

Igo T 130

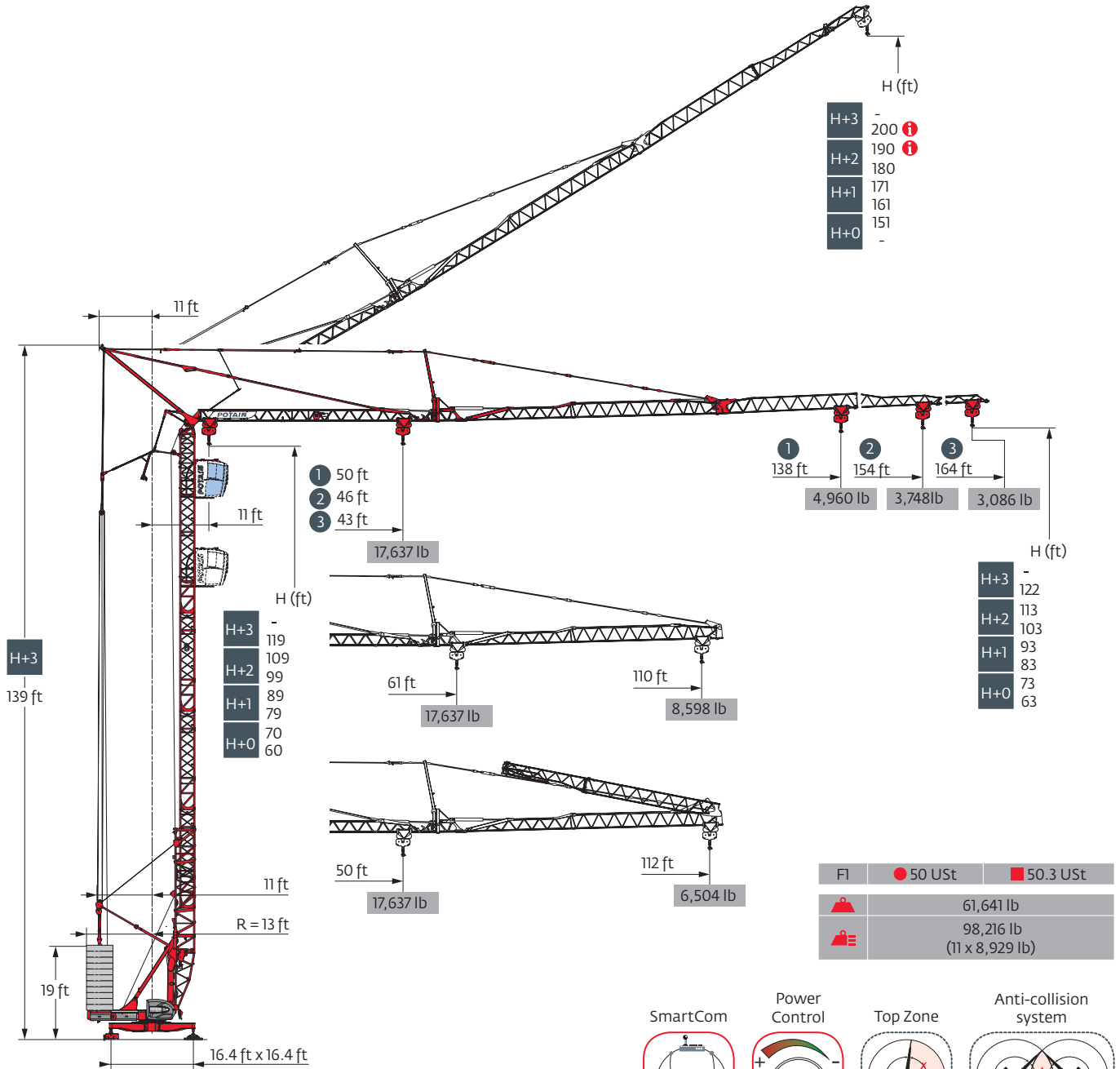

North American market utilizes 12 counterweight slabs, please consult factory for dimensions information.

Load curves

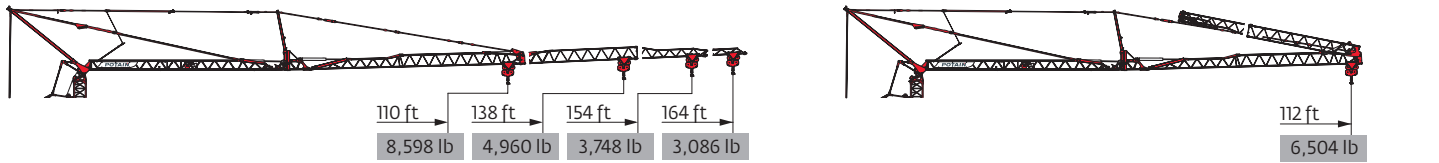

164 ft	11	▶	43	46	52	59	66	72	74	75	79	85	92	98	105	112	118	125	131	138	144	151	157	164	ft
▲▲▲																									lb
																									lb
																									lb
154 ft	11	▶	46	49	52	59	66	72	79	80	82	85	92	98	105	112	118	125	131	138	144	151	154	ft	
▲▲▲																									lb
																									lb
																									lb
138 ft	11	▶	50	52	59	66	72	79	82	85	88	89	92	98	105	112	118	125	131	138				ft	
▲▲▲																									lb
																									lb
																									lb
110 ft	11	▶		61	66	72	79	82	85	89	92	98	105	108	110										ft
▲▲▲																									lb
																									lb
																									lb

164 ft	11	▶		50	52	59	66	72	79	85	88	92	98	105	112									ft	
▲▲▲																									lb
																									lb
																									lb

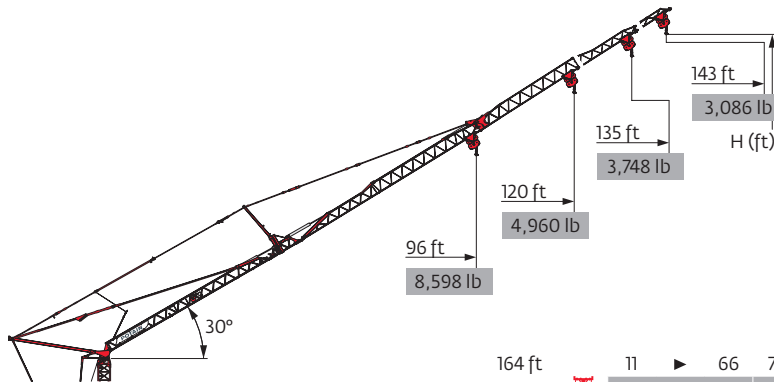

▲▲▲		164 ft	154 ft	138 ft	110 ft
H+3	ⓘ	200	195	-	-
H+2	ⓘ	190	185	-	-
		180	175	166	151
H+1		171	165	156	141
		161	156	147	132
H+0		151	146	137	122



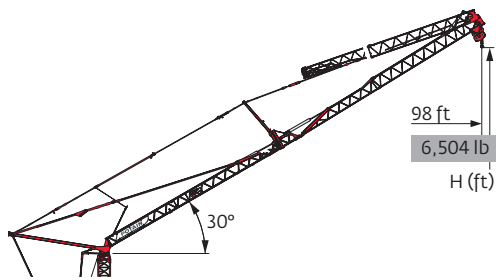



164 ft	11	▶	66	72	79	85	92	98	105	112	118	125	131	138	143	ft
▲▲▲																lb
																lb
																lb
154 ft	11	▶	70	72	79	85	92	98	105	112	118	125	135		ft	
▲▲▲																lb
																lb
																lb
138 ft	11	▶		77	85	92	98	105	112	120					ft	
▲▲▲																lb
																lb
																lb
110 ft	11	▶							94	96					ft	
▲▲▲																lb
																lb







▲▲▲	164 ft
	154 ft
	138 ft
H+2	152
H+1	142
	133
H+0	123

164 ft	11	▶		77	79	85	92	98							ft	
▲▲▲																lb
																lb

Mechanisms

480 V - 60 Hz												hp	kW	
	33 LVF 20 Optima	fpm	10	52	112	174	207	5	26	56	87	103	29.5	22
		lb	8,818	8,818	8,818	4,409	2,205	17,637	17,637	17,637	8,818	4,409		
	5 DVF 5	fpm	49 - 98 - 128 (4,409 → 17,637 lb) 49 - 98 - 180 (441 → 4,409 lb) 49 - 98 - 230 (0 → 441 lb)									5.4	4	
	RVF 161 Optima+	rpm	0 → 0.8									7.5	5.5	
	TVF 124	fpm	82									2 x 4	2 x 3	

 IEC 60204-32	 kVA
480 V (+6% -10%) 60 Hz	 31 → 19 kVA  35 → 22 kVA 

33 LVF 20 Optima

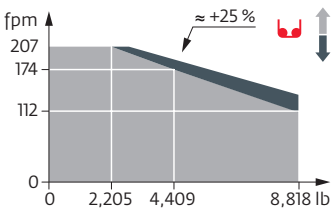

Erection

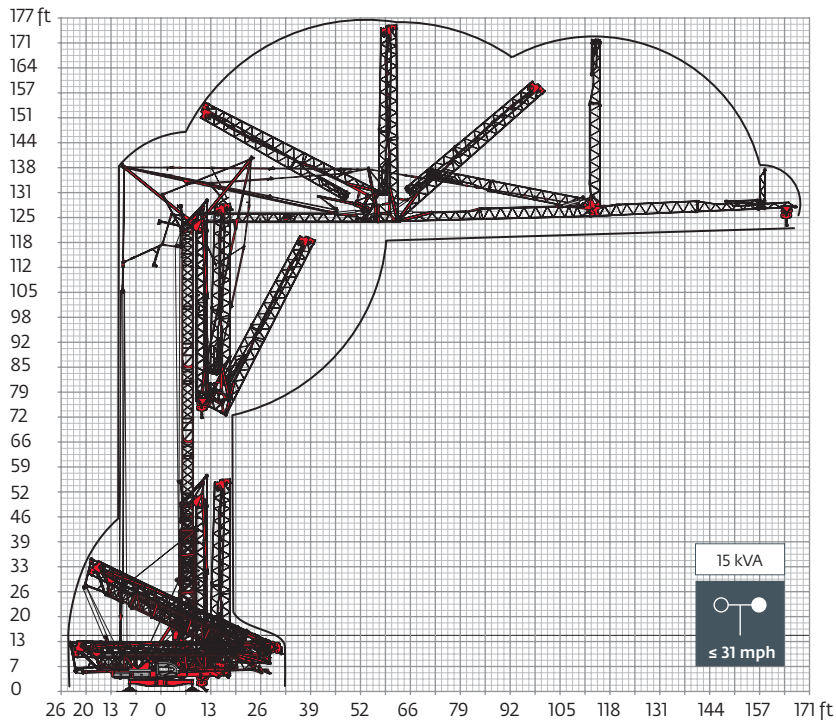

Transport

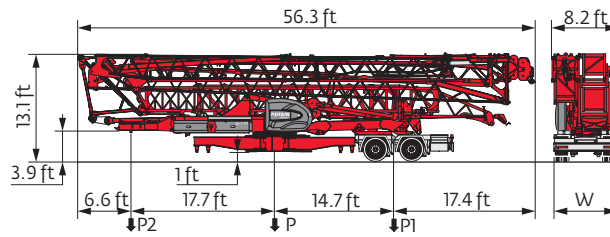

	mph	W (ft)	P (lb)	P1 (lb)	P2 (lb)
SL121/S215M	15.5	7.9	66,359	42,549	23,810

NORTH AMERICAN HIGHWAY AXLE

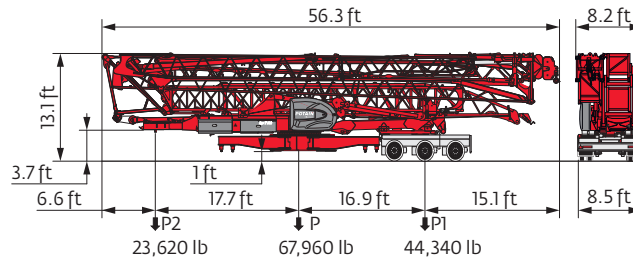

- R Rear slewing radius
- i Consult us
- Reactions in service
- Reactions out of service
- ⚖ Weight without load, without ballast, without transport axles, with max. jib and standard height
- 🏠 Total ballast weight
- Standard equipment
- ⊞ Options
- Hoisting
- Trolleying
- Slewing
- Travelling
- kVA Required power
- ⏱ Power Control Function: winch speeds adapted to the available power

⚠ This commercial document is not legally binding. For any technical information, please refer to the corresponding instructions.

