

FBGRU

1179.60

(1,105 lb, 79 / 60')



GRU
A
T
O
R
R
E

GA 245

GRU AUTOMATICA CON
MONTAGGIO IDRAULICO

GA compact



GX



GHS topless



25 km/h

RAPIDE

VELOCE

FAST

SCHNELL

RÁPIDA

80 km/h

FBGRU
LIFT YOUR GOALS!

FB F.lli Butti s.r.l.

Via XXV Aprile, 58

23868 Valmadrera (LC) - Italia

Tel. 0341.581108 - Fax 0341.200253

E-mail : fbgru@fbgru.it - <http://www.fbgru.it>

CE

FEM 1.001 - A3
EN 14439 - C25

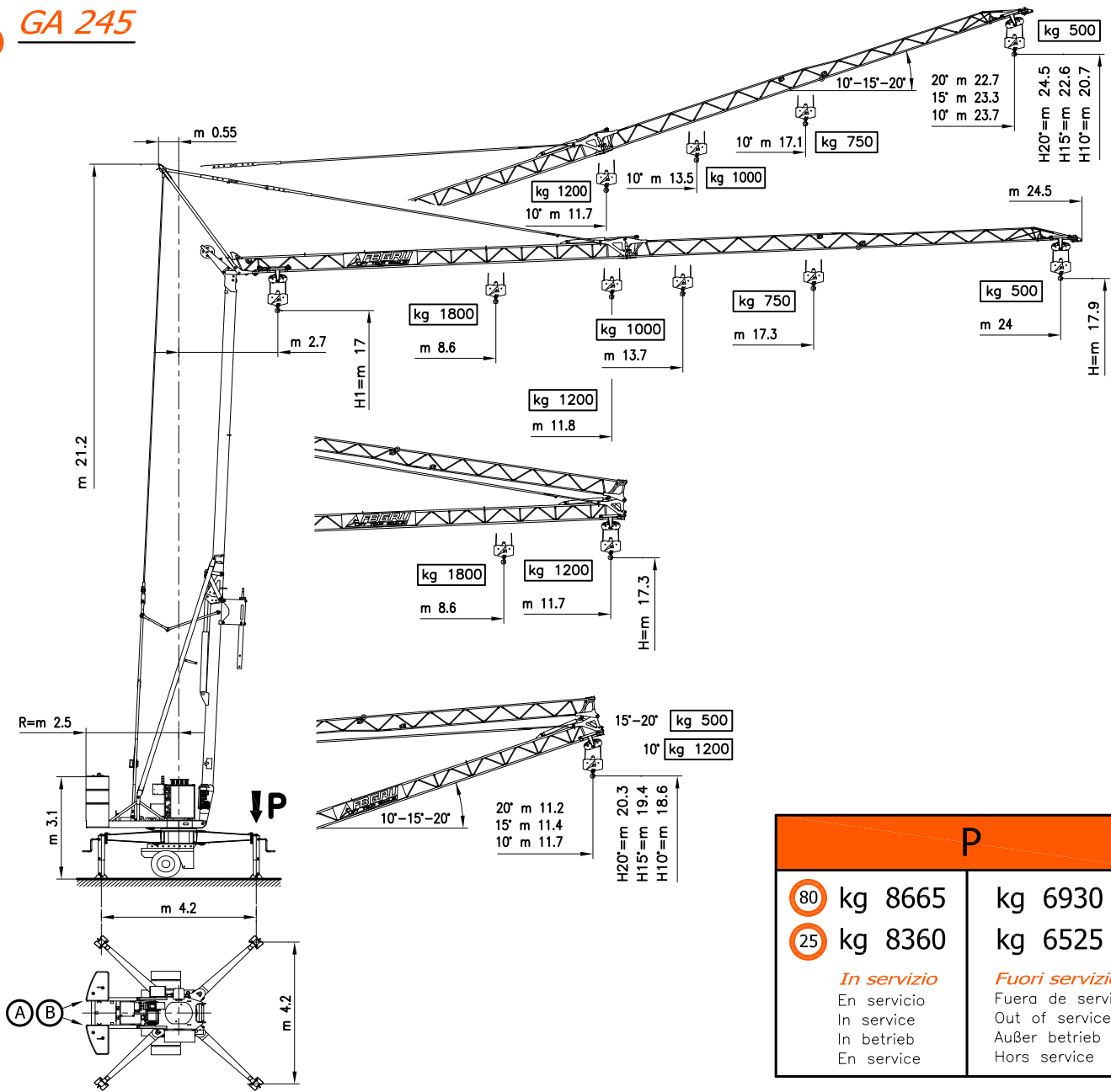

P	
80	kg 8665
25	kg 8360
<i>In servizio</i>	
En servicio	
In service	
In betrieb	
En service	
80	kg 6930
25	kg 6525
<i>Fuori servizio</i>	
Fuera de servicio	
Out of service	
Außer betrieb	
Hors service	

80	(A)	(B)
	N° 2x2200	N° 4x600 N° 2x1000
	kg 12050	
25	(A)	(B)
	N° 2x2200 N° 1x300	N° 4x600 N° 2x1000 N° 1x300
	kg 11760	
		80 kg 7650
		25 kg 7060

LA GRU LA GRÚA — CRANE
KLAN — GRUE



MOVIMENTO MOVIMIENTO MOVEMENT BEWEGUNG MOUVEMENT	ALIMENTAZIONE ALIMENTACION OPERATING VOLTAGE BETRIEBSSPANNUNG TENSION DE SERVICE	PRESTAZIONI FUNCIONAMIENTOS PERFORMANCES LEISTUNGEN EXÉCUTIONS	
---	---	---	---

SOLLEVAMENTO ELEVACION — HOISTING HEBEN — LEVAGE INVERTER 	230 V 50 Hz	3 kW	1 ^a m/1' - kg	2 ^a m/1' - kg	3 ^a m/1' - kg	4 ^a m/1' - kg	kW 5.5
		4.5 kW	4	7	12	25	
	400 V 50 Hz	3 kW	1800	1800	1200	500	
		4.5 kW	4	12	25		
		3 kW	1800	1800	750		
		4.5 kW	4	14	25	39	
3 kW	1800	1800	1200	750			

CARRELLO CARRILLO — JIB TROLLEY LAUFKATZE — DISTRIBUTION INVERTER 	230 - 400 V 50 Hz	1 ^a m/1'	2 ^a m/1'	3 ^a m/1'	kW 1.8
		12	20	38	

ROTAZIONE ROTACION — SLEWING DREHEN — ORIENTATION INVERTER 	230 - 400 V 50 Hz	1 ^a g/1'	2 ^a g/1'	3 ^a g/1'	kgm 1.2
		0 → 0.19	0.19 → 0.46	0.46 → 0.93	



Conforme alle direttive
CEE sul livello acustico
2000/14/CE

Conforme con las directivas
CEE sobre el nivel acustico

In compliance with the EEC
instructions on noise level

Gemass EWG-Richtlinien für
den Schall-Leistungspegel

Conforme aux directives CEE
sur le niveau acoustique

CURVE DI CARICO

CURVAS DE CARGAS — LOAD DIAGRAMS

LASTKURVEN — COURBES DE CHARGES

V24 

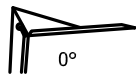
	m	2.7	5	8.6	9	9.9	11	12	13.7	15	16	17.3	18	19	20	21	22	23	24
	kg	1800			1692	1500	1318	1182	1000	896	826	750	714	667	626	589	556	526	500

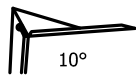
	m	2.7	5	8	9	10	11.7	12	13.5	15	16	17.1	18	19	20	21	22	23	23.7
	kg	1200						1162	1000	883	815	750	705	660	619	583	551	521	500

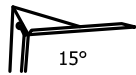
	m	2.7	5	8	10	15	20	23.3
	kg	500						



	m	2.7	5	8	10	15	20	22.7
	kg	500						

(0 - 1800 kg)	
---------------	---

POTENZA RICHIESTA

POTENCIA-ELECTRICA NECESARIA — NECESSARY ELECTRIC POWER

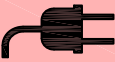
KRAFTBEDARF — PUISSANCE ELECTRIQUE NECESSAIRE

	SOLLEVAMENTO ELEVACION — HOISTING — HEBEN — LEVAGE	 kg 1800
	3 kW - 4.5 kW 230 V - 50 Hz	8 kW 400 V - 50 Hz

TRASPORTO TRANSPORTE — TRANSPORT
TRANSPORT — TRANSPORT

80
km/h

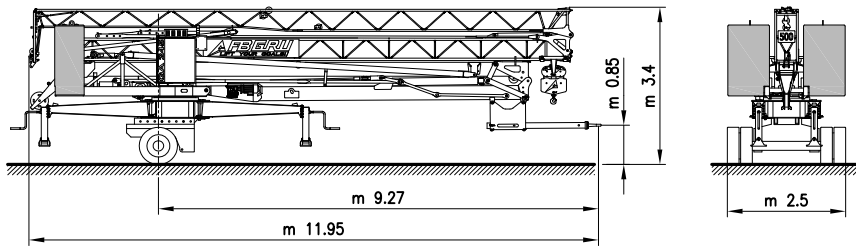

MONTAGGIO MONTAJE — ERECTION
MONTAGE — MONTAGE

